



Co-Packaging Label Specifications

Document Distribution: This is a specifications document for circulation to clients, label designers, printers, and label converters. Please make sure the appropriate personnel in your company are given this information.

Purpose: To inform customers, label designers, printers and suppliers of Artus's Specifications to ensure that supplied pressure sensitive labels are of a size and quality capable of being applied mechanically on our automated bottling lines.

Guidance: Our experienced staff is available to answer any queries regarding the contents of this Specification. They can also organize trials of labels to ensure satisfactory results prior to bottling.

The Label Graphs (attached as Appendix A) can be used as a measurement aid when designing labels. In our experience, label sizes shown on the Graphs are the most appropriate for our automated bottling lines.

We understand customers may prefer larger labels for particular products. To assess whether these can be applied successfully on our automated bottling lines, we recommend that sizing is stated early in the design stage to assess and, where necessary, arrange for trials to be organized prior to the actual bottling date.

Note: The scale of the graph and diagrams, when printed, is dependent on the accuracy of the printer being used. Ensure that the document is printed at 100% scale and not 'to fit'.

Responsibility: It is the responsibility of customers, their label designers and printers to:

Ensure labels provided to Artus are manufactured with reference to the information contained in this Specification and be fit for purpose.

Collaborate, select and use the most suitable paper types, varnishes and adhesives for their intended label requirements and expectations. Labels must perform on Artus automated bottling lines and successfully adhere with minimal lifting or bubbling when exposed to various temperatures and humidity from the warehouse to the ice bucket.

It is strongly recommended that customers check and approve labels at their printer's premises or receive samples for approval prior to delivery to Artus. All labels should be used within the suggested label expiry date.

Initial _____, Date: _____

Requirements: This section sets out label requirements for application on Artus's automated bottling lines. We understand that from time to time our customers will have labels that do not meet all of these requirements and we will work with you to achieve best application results.

1. Automated Application Capabilities

FB-1 for body labels (front and back on single web)

- or -

FB-2 for body labels (front and back on separate webs)

Sparkling shoulder labels

2. Paper Weight

- (a) Body labels require a minimum paper weight of 60# and a maximum thickness of 0.0050".

3. Label Design

- (a) Special care is required when choosing wine labeling papers, as some stocks can be thick and absorbent, or highly embossed making them stiff. If an open weave paper is to be used then we recommend one with a low COBB value to reduce the risk of bubbling/lifting. It is also essential that the surface area of the paper stock is sufficiently sealed with moisture repelling varnish.
- (b) The use of under laminates is recommended for products that require refrigeration.
- (c) Heavy embellishment or embossing can reduce the adhesive bond area of a label to the glass. **The greater the extent and depth of the embossing, the greater the chance of failure.**
- (d) Labels that have all over emboss/embellishment must have a 5mm emboss free zone measured from each label edge to aid adhesion and help prevent label lifting from the glass post bottling.
- (e) Foil stamping can stiffen the label and reduce adhesive contact with the glass, making the label lift from the bottle after it has been applied.
- (f) High gloss/reflective metallized labels will highlight all minor irregularities in the glass surface, e.g. bottle seams etc.
- (h) Permanent adhesives with high initial tack (bond) must be used and be compatible with condensation on glass.

Initial _____, Date: _____

Summary - The main causes of label lifting or bubbling/creasing of labels are:

- Paper stock over 90#
- Open weave paper (uncoated and matt)
- Excessive emboss/embellishment
- Foiling/metal finish
- Bottle sink and bulge

Note: Evidence of lifting or bubbling becomes apparent after bottling.

4. Label Size

4.1 Body labels

- (a) The Label Graph (Appendix A) shows, in our experience, what reliable label sizes are for our automated bottling lines.
- (b) If your label does not fit into the dimensions shown in the Label Graph we recommend that we are advised early in the design stage so that we can offer our assessment before print and/or organize trials well before the actual bottling date.

Artus Bottling cannot be held responsible for labelling issues stemming from label size and application due to out of roundness or bulges/sinks on the bottles. Extra winery staff will be required when these situations occur.

- (c) Minimum label height is 7mm (see Appendix B).
- (d) Maximum label height is 180mm (see Appendix B).
- (e) Minimum label width 12mm (see Appendix B).
- (f) Maximum label width 300mm combined front and back (see Appendix B).
- (g) The requirements for 375ml, 180ml and other size bottles are varied and therefore all labels must be assessed and, where necessary, undergo trials prior to the actual bottling date.

While these are measurements that Artus equipment can label, application issues may arise due to extreme values. For recommended label dimensions to best fit standard bottle sizes, refer to Appendix A.

4.2 Shoulder labels

- (a) Shoulder Labels Diagram (Appendix B) shows examples of shoulder label shapes. Label designers are responsible for shaping and sizing shoulder labels to fit the specific application height, bottle shoulder shape and closure being used (sparkling hood). A sample bottle with closure being used should be supplied to your designer. For sparkling wine, it is important to let the designer know what length of hood is to be used ie 122mm or 80mm).

Initial _____, Date: _____

5. Positioning of labels on bottles

5.1 Body labels,

Our guidelines for placement of standard size body labels on 750 ml bottles are:

- (a) Minimum 40mm gap between front and back label (20mm left and 20mm right).
- (b) The top of the label should be 5mm above the bottom of and below the top of the bottle manufacturer's label panel specification
- (c) The requirements for 375ml, 187ml and other size bottles are varied and therefore all labels must be assessed and, where necessary, undergo trials prior to the actual bottling date.

5.2 Shoulder labels

- (a) Placement of shoulder labels must be assessed individually to ensure that the size and shape are correct for the selected bottle

5.3 Clear labels,

- (a) If the label design does not have a full width block of solid colour to use for optically "spotting" the label gap, the back of the lining paper must have a solid block of colour printed onto it to identify the die gap

6. Gap, Squareness & Lift & Fall Movement Tolerances

	Gap	Lift and Fall	Squareness
Front and Back Label	+/- 4mm	+/- 2mm	+/- 1mm
Shoulder	N/A	+/- 2mm	+/- 1mm

7. Body Label Roll Diagrams

- (a) The Label Roll Diagrams (Appendix B) provides a visual of dimensions, weight, die gap, and webbing information for body labels.
 - (i) All label rolls to be supplied as industrial standard unwind left hand lead
 - (ii) PET webbing is recommended to reduce breaks during the labeling process..
 - (iii) The distance between labels (die gap) on the webbing must be consistent across all label rolls (minimum 3mm maximum 15mm) to assist with satisfactory label application on our automated bottling lines.

Initial _____, Date: _____

(iv) The webbing height must be greater than the size of the label. We recommend a minimum 2mm and maximum 5mm (with a variation of no more than +/-0.25mm across the label run.) This webbing distance must be consistent across all label rolls.

(v) Maximum label roll weight 8kg and individual carton weights no greater than 16kg

(vi) All label converting waste (eg matrix waste) must be removed from webbing ready for automated application.

7.1 Body Labels

(a) Label roll size maximum 280mm.

(b) Core width 76mm (3") inside diameter.

(c) Labels must be within 40mm from top or bottom edge of web in order for the label sensor to be able to detect.

7.2 Shoulder Labels

(a) Label roll size maximum 280mm.

(b) Core width 76mm (3") inside diameter.

Initial _____, Date: _____

IMPORTANT NOTES

The winery is responsible for the down-time charges related to the following issues with their labels and the printing there of which may result in:

(a) Die strike issues:

- Liner tearing may occur if die strikes are too deep and the liner is compromised.

(b) Release issues:

- Silicone voids. Silicone voids may cause the label to adhere to the liner and not release at the peeler bar subsequently causing a “V” type tearing of the liner.
- Excessive release agent. Excessive release agent may cause the label to separate from the liner prior to the peeler bar.

(c) Bubbling:

- Bubbling due to moisture/water. Unsuitable adhesive, stock, and/or varnish for the intended use. Choices in adhesive, stock, and/or varnish need to match the intended application. If the label fails the ice bucket test, it will bubble when exposed to moisture or water.
- Deep embossing/embellishment. Deep embossing/embellishment and or ornate embossing/embellishment may reduce the surface contact of the label to the bottle reducing the adhesion. Use of suitable adhesive is paramount.

Excessive label waste and downtime charges will occur for these avoidable issues.

Initial _____, Date: _____

Appendix A

Label Size Graph for Pressure Sensitive Single Label

Scale 1:1 (Print actual size, not to fit)

Grid spacing 5mm x 5mm



For 750mL bottles

Directions

- Align the label vertically starting in the bottom left-hand corner along the “X” and “Y” axes.
- The label should fit within the outline of the graph for your bottle choice to be suitable for application on Artus Bottling Ltd. bottling lines.
- These specifications are for standard bottle dimensions. Requirements for other bottle sizes and styles may vary.
- Correct label size does not guarantee perfect application due to other specifications including, but not limited to, label type, label placement, and bottle roundness.

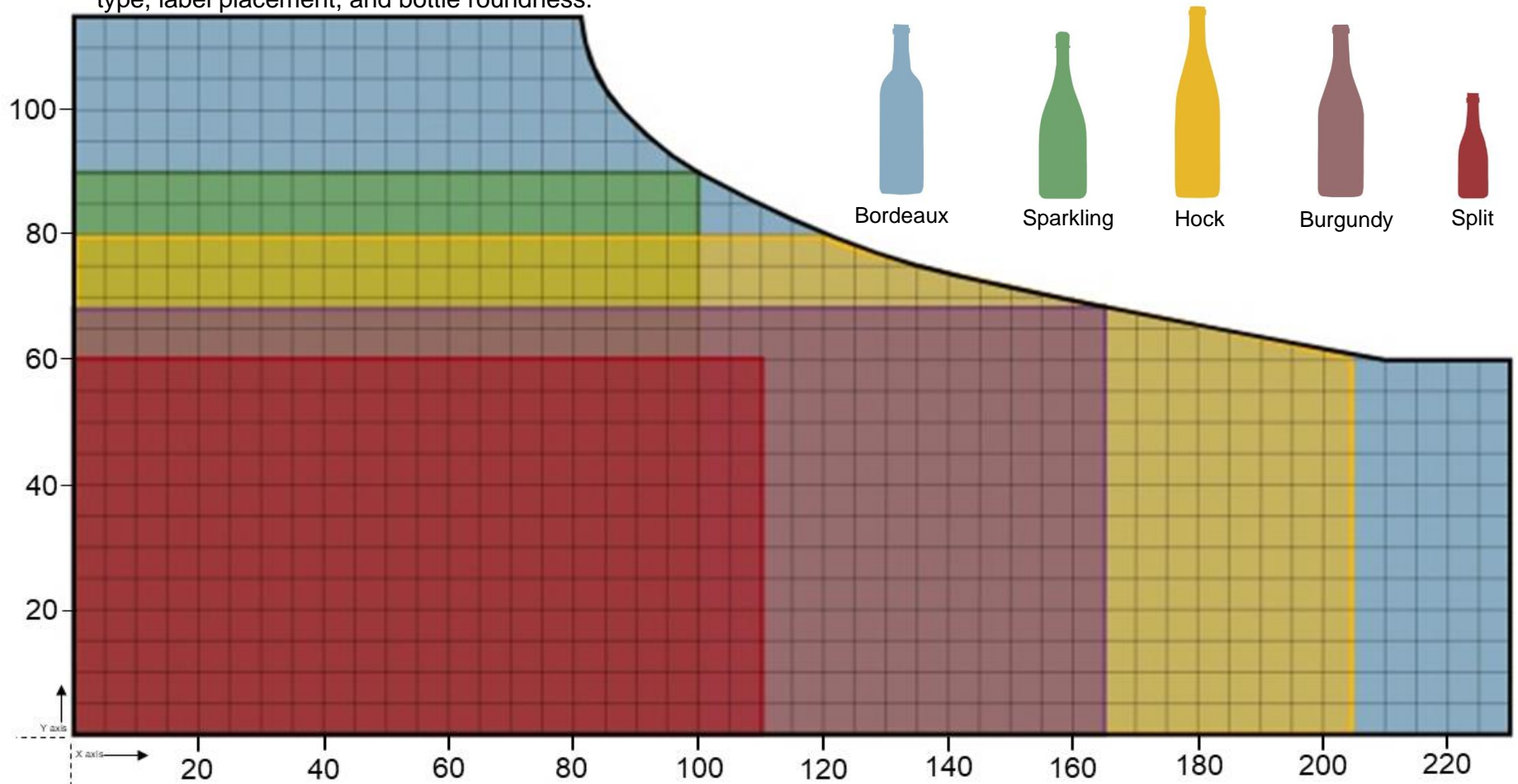

Adapted from *Wine Packagers of Australia Inc. specification for pressure sensitive labels, October 2014.*



Appendix B

Roll Sizes and Unwind Direction

BODY LABEL

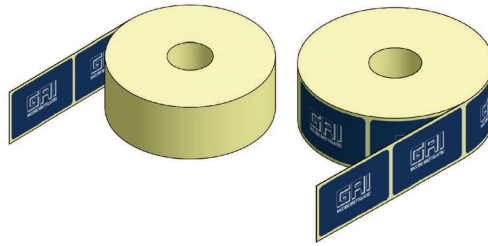

Max external diameter 280 mm
Internal diameter 76 mm

SHOULDER LABEL

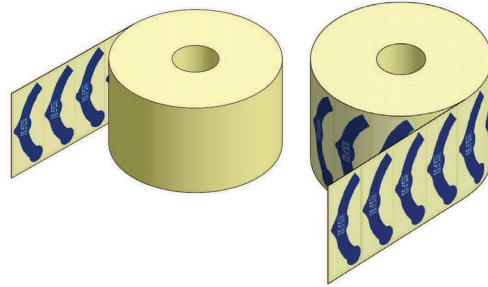

Max external diameter 280 mm
Internal diameter 76 mm

Front and Back Label Sizes, FB-2

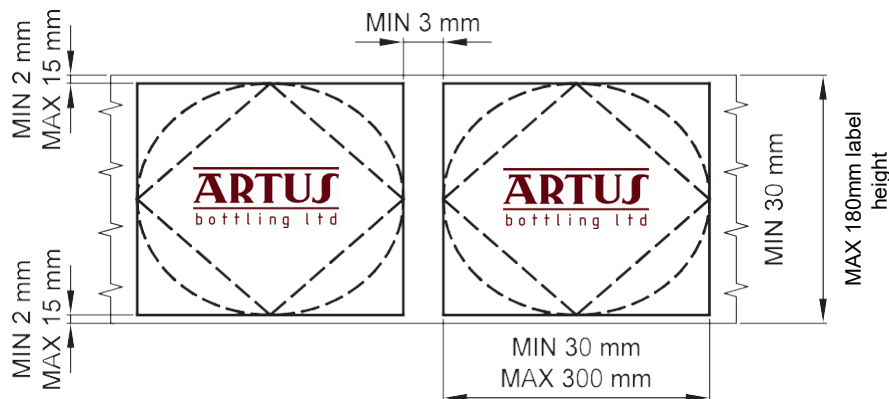

Front and Back Label Sizes on Same Roll, FB-1

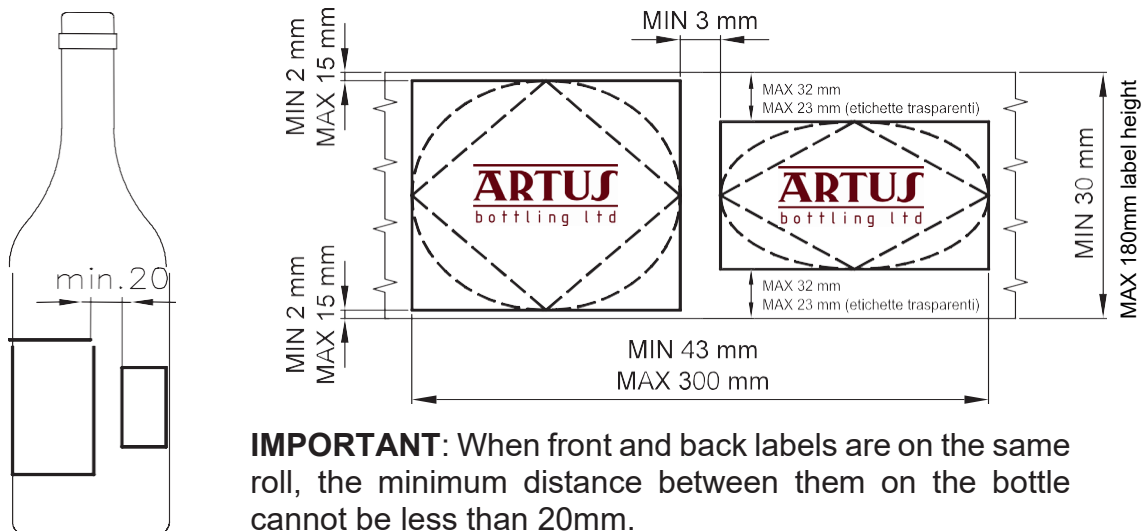

IMPORTANT: When front and back labels are on the same roll, the minimum distance between them on the bottle cannot be less than 20mm.

Dimensions and Sparkling Shoulder Label

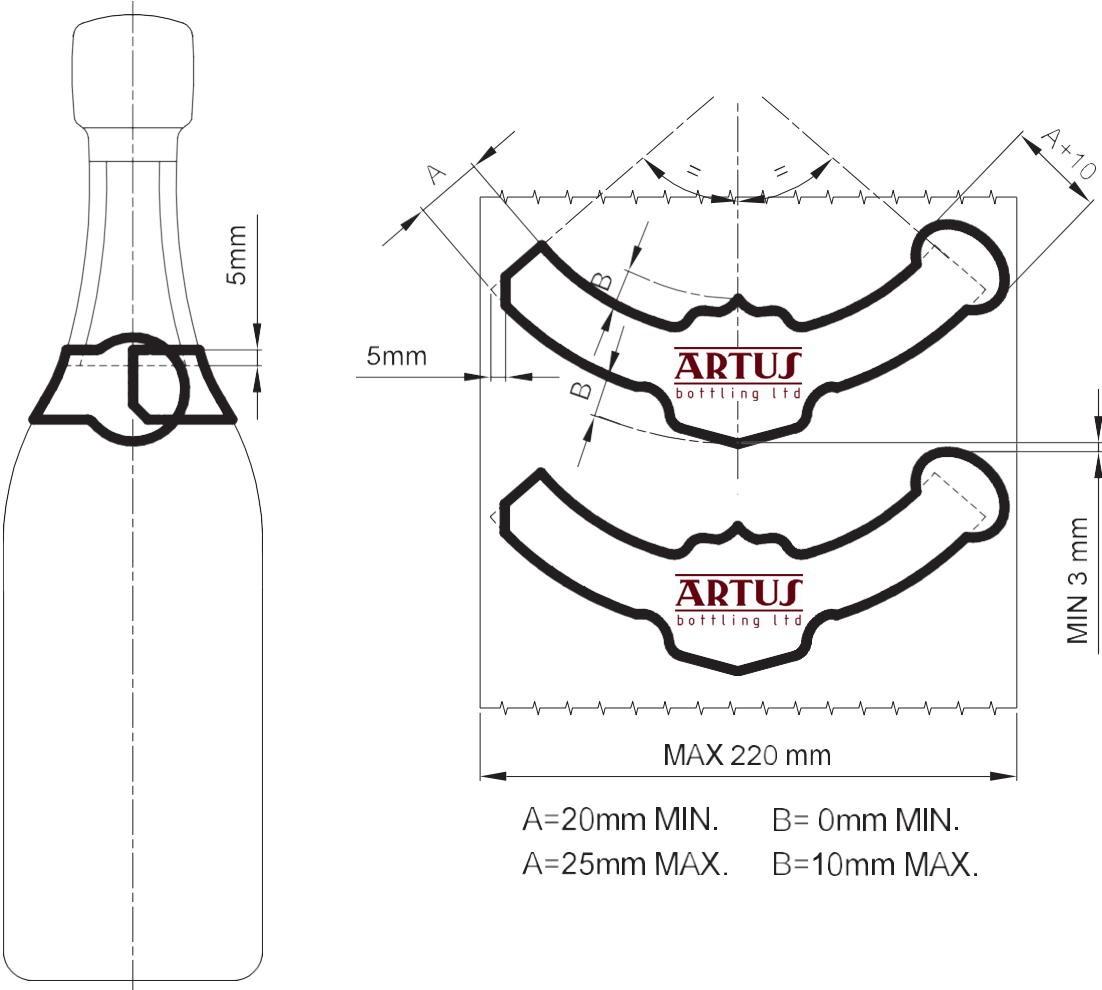

Sparkling Foil Capsule Spots

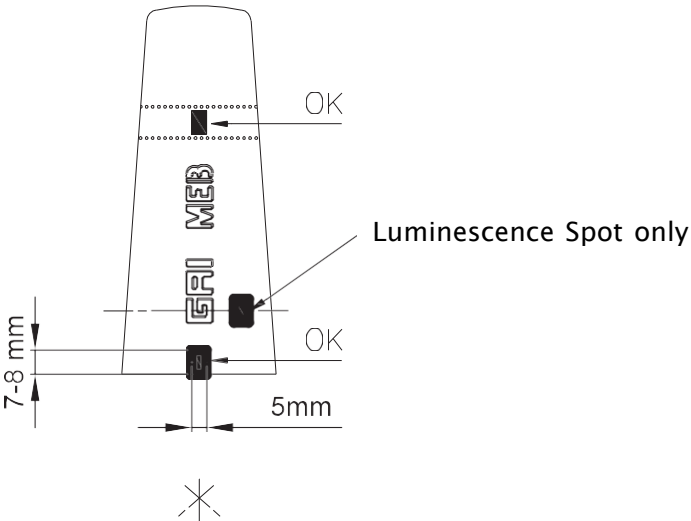



Co-Packaging Label Specifications ADDENDUM

Sparkling / Cider Labels

Document Distribution: This is a specifications document for circulation to clients, label designers, printers, and label converters. Please make sure the appropriate personnel in your company are given this information.

Purpose: To inform customers, label designers, printers and suppliers of Artus's Specifications to ensure that supplied pressure sensitive labels are of a size and quality capable of being applied mechanically, on our automated bottling lines to product filled under counter pressure, i.e. Charmat, Sparkling, Cider.

Guidance: Our experienced staff is available to answer any queries regarding the contents of this Specification. They can also organize trials of labels to ensure satisfactory results prior to bottling.

The attached Label Graphs should be used as a measurement aid when designing labels. In our experience, label sizes shown on the Graphs are the most appropriate for our automated bottling lines.

Note: The scale of the graph and diagrams, when printed, is dependent on the accuracy of the printer being used. Ensure that the document is printed at 100% scale and not 'to fit'.

Responsibility: It is the responsibility of customers, their label designers and printers to:

Ensure labels provided to Artus are manufactured with reference to the information contained in this Specification and be fit for purpose.

Requirements:

1. Paper

Welded paper (i.e., Wine Weld – UPMRafaltac, Aqua Stick – Fasson/Avery Dennison)

- or -

BOPP (min 2 Mil)

Initial _____, Date: _____

2. Adhesive

AT20 or RS30

S100R is unsuitable

3. Label Size

4.1 Body labels

The smaller of:

A label that fits within the shaded area of the attached Label Graph.

-- or --

Max label height should be 15mm less than height of label panel.

Max label width should be 37% of the circumference of the bottle.

Artus Bottling cannot be held responsible for labelling issues stemming from poor paper/adhesive selection, label size and application due to out of roundness or bulges/sinks on the bottles. Extra charges will apply when these situations occur.

Initial _____, Date: _____